

ELP

Hydraulic weighing system for electric pallet stackers and pallet trucks

OPERATING INSTRUCTIONS

ENGLISH

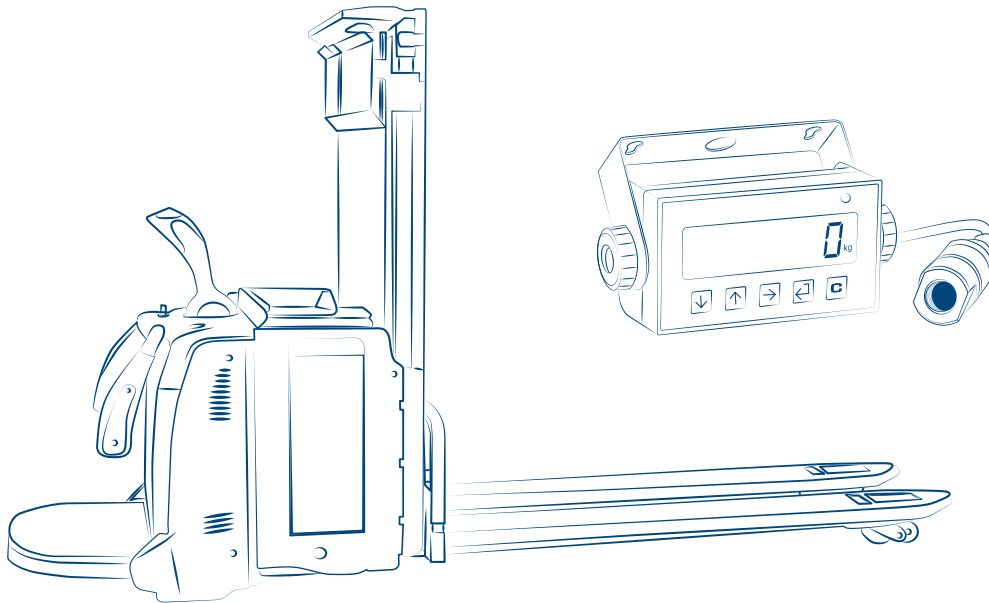

Introduction	4
Warnings	4
Display and keyboard	5
Accuracy factors	7
Weight reading	8
Basic functions	8
Switching on	8
Switching off	9
Adjusting the display brightness	9
Setting a known tare value (PT)	10
Clearing the tare	10
Print	11
Metric information	11
Advanced functions of the scale	12
How to enter the functions menu	12
Horizontal weight totalisation	13
Exchange between net weight and gross weight	15
Unit of measure conversion	16
Configuration menu	18
Maintenance	23
Replacing the printer paper roll	23
Notes	24

Introduction

Dear Customer,
Thank you for purchasing a DINI ARGEO product.

This manual explains the usage of the hydraulic weighing system for electric pallet trucks.
In particular, all the functions of the electronic part of the scale are described to assist the forklift driver during use.



For any additional information or specific requests, please contact your local dealer.
This publication is optimised for A4 printing.



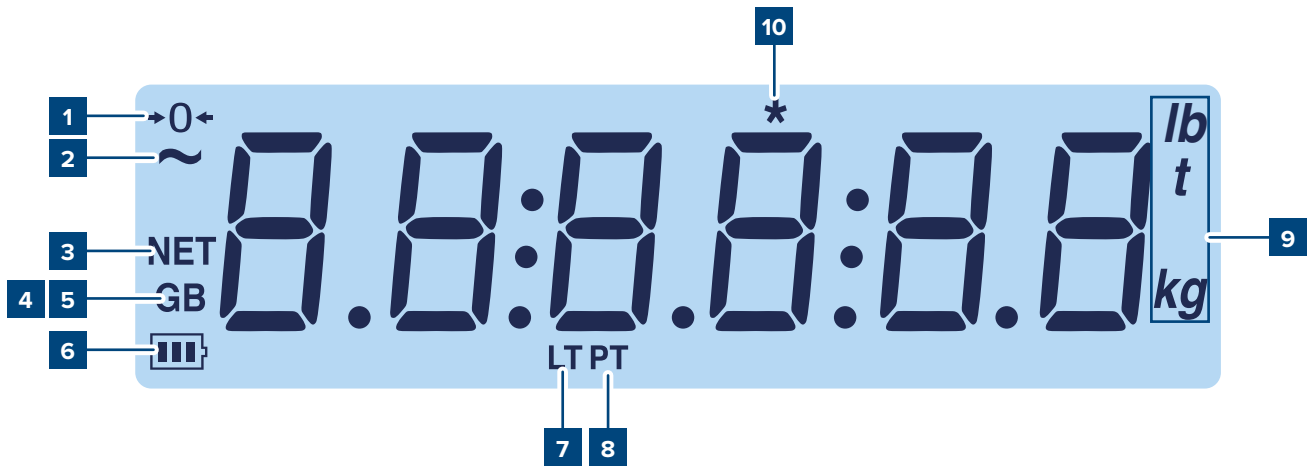

Warnings

- The weighing system does not change the safety regulations normally applied to the pallet truck.
- Before weighing, make sure that the pallet truck is stationary, on a flat surface and that there are no people in the area around the load.
- The employee training on the use of the system is the purchaser's responsibility.
- Please read this manual carefully before using the system.
- Assistance must only be carried out by personnel authorised by Dini Argeo.
- Dini Argeo is not responsible for any weighing errors resulting from improper use of the system.



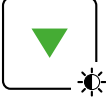

ITEM	ICON	DESCRIPTION
1	→0←	This indicates that the scale is empty (gross zero).
2	~	This indicates that the weight is unstable.
3	NET	The net weight is displayed. Note: A tare has been stored.
4 / 5	G B	The gross weight is displayed.
6		This indicates the battery level: 
7	LT	A tare has been blocked.
8	PT	A manual tare is active.
9	lb ... kg	This indicates the unit of measure: pounds (lb), tons (t), kilograms (kg), grams (g).
10	*	This indicates that a key has been pressed. In some operating modes, this indicates that a specific function is active.
11	----	Weight acquisition phase.

Key	Description
	<ul style="list-style-type: none"> For numerical entries, decreases the value. If pressed for a long time (2 sec), it allows you to set the brightness of the display.
	<ul style="list-style-type: none"> For numerical entries, increases the value. If pressed for a long time (2 sec) it allows you to insert a preset tare.
	<ul style="list-style-type: none"> Recalls the function specific to the operating mode. For numerical entries, to change the selected digit If pressed for a long time (5 sec) it allows you to change the operating mode.
	<ul style="list-style-type: none"> Confirm key. Print the receipt. If pressed for a long time (5 sec) it allows you to enter the configuration menu.
	<ul style="list-style-type: none"> If pressed for 2 seconds, it turns off the instrument. If pressed for 5 sec it shows the metrological information.



WARNING







For a clearer view and advanced key and mode functions, see the chapter “BASIC FUNCTIONS” and “ADVANCED FUNCTIONS”.

Accuracy factors

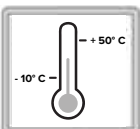
The system is based on the measurement of the oil pressure contained in the hydraulic lifting circuit by means of a specific sensor. This pressure depends on the load on the forks and the height of the forks, which is why weighing operations must always be carried out at the same height (indicated by the stickers).

The theoretical precision of the ELP system, correctly installed on suitable electric pallet trucks and used under optimal conditions, varies from 0.5% to 5% of the capacity (min. 20 kg).

This accuracy is adversely affected by the following factors:

	<p>Type and state of wear of the pallet truck.</p>
	<p>Ambient temperature: the temperature range of the sensor is from - 10° C to + 50° C.</p>
	<p>Mechanical friction: keep sliding parts clean and lubricated.</p>
	<p>Oil leaks.</p>
	<p>Load position on the forks: the gravity centre of the load must be positioned in the centre of the forks.</p>
	<p>Lifting speed: lift the load at a constant speed and without sudden dashes so as to avoid jolts.</p>
	<p>Position of the sensor inside the hydraulic circuit. Refer to the technical manual for sensor installation.</p>
	<p>Type of oil in the hydraulic circuit: use oils with low viscosity and suitable for a wide temperature range.</p>



A PALLET MUST ALWAYS BE USED DURING WEIGHING OPERATIONS

Weight reading

Before turning on the weight indicator, make some lifting with empty forks (at least 5) to heat the oil inside the hydraulic circuit.

With the forks down, turn on the weight indicator and wait for it to zero.

During load acquisition the display shows: ----

At the end of the acquisition, the weight is shown.

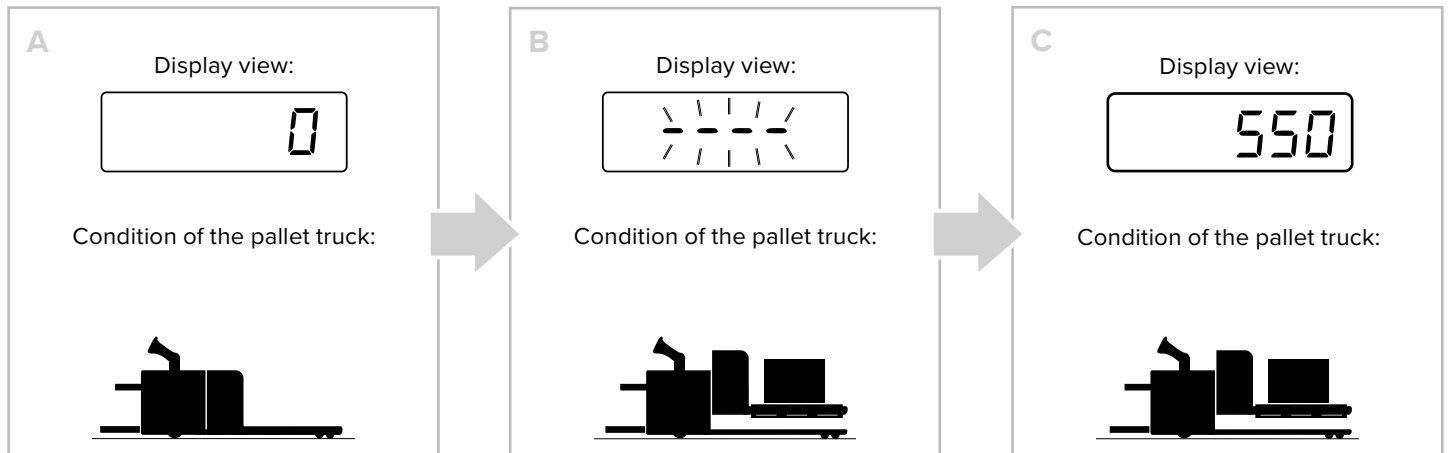

Between weighing operations, the weight must return to 0 by lowering the forks completely.

Basic functions

Switching on

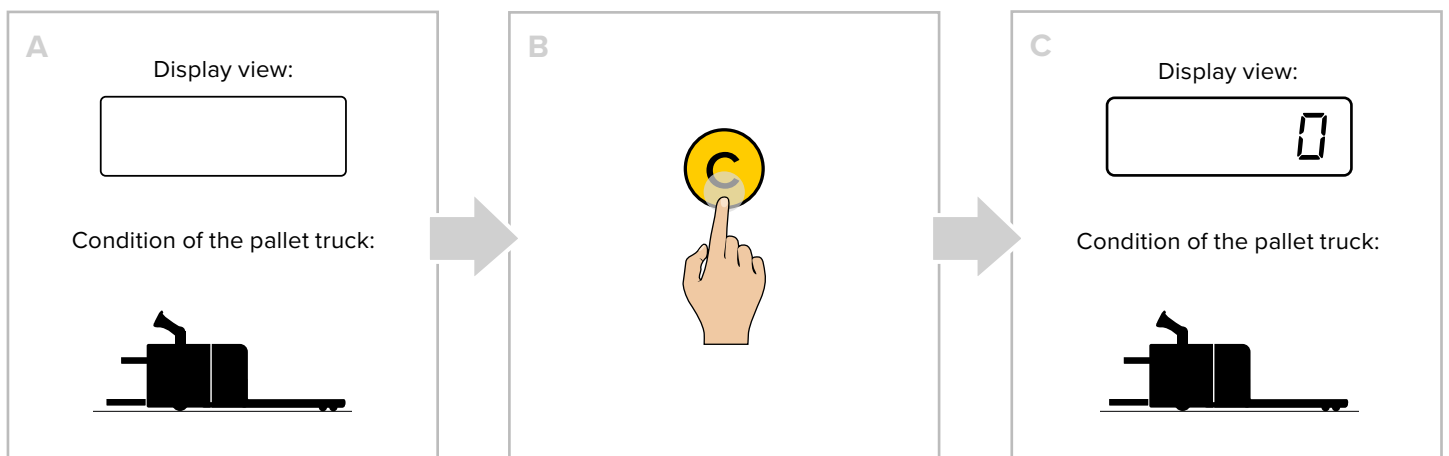

Switching off

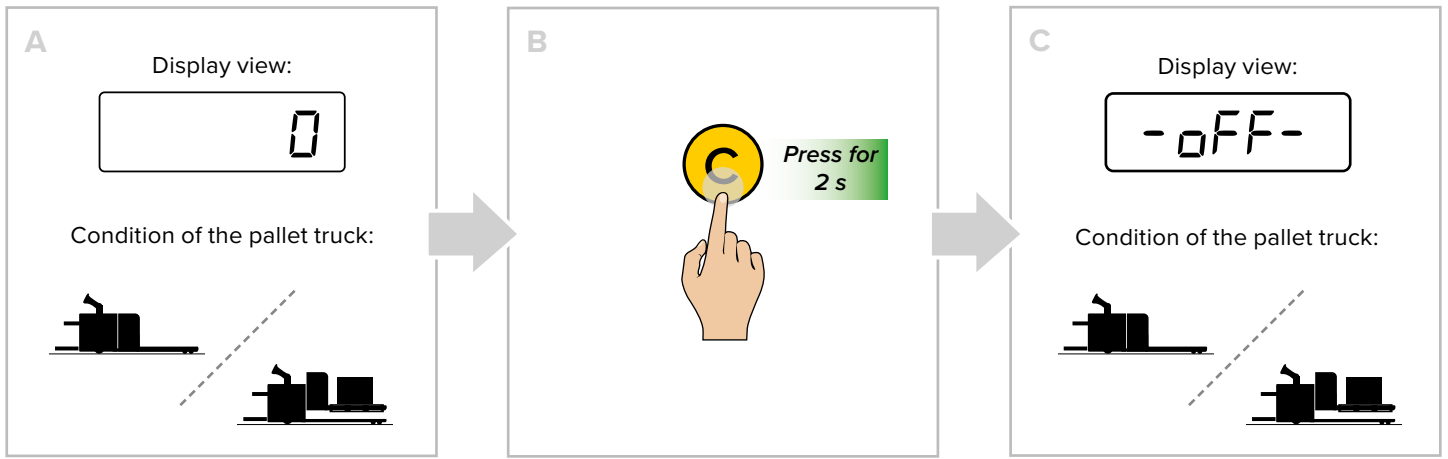

Adjusting the display brightness

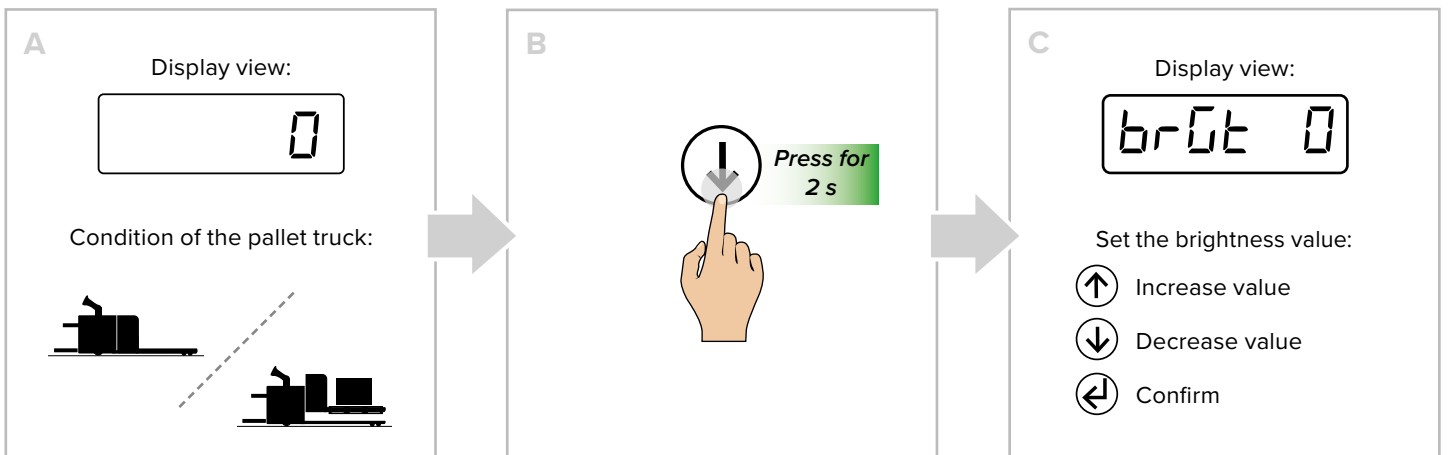

Setting a known tare value (PT)

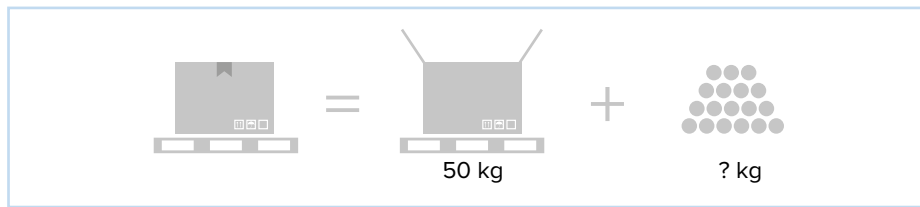

A Display view:

Condition of the pallet truck:

B Press for 2 s

C Display view:

Setting the tare value: Increase / decrease the value

D PRINT

E Display view:

Condition of the pallet truck:

F Display view:

Condition of the pallet truck:

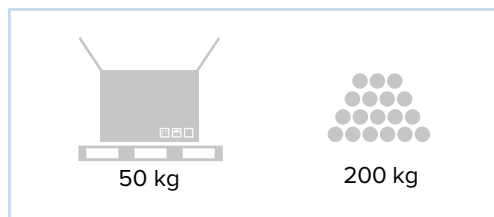

Clearing the tare

A Display view:

Condition of the pallet truck:

B

C Display view:

Condition of the pallet truck:

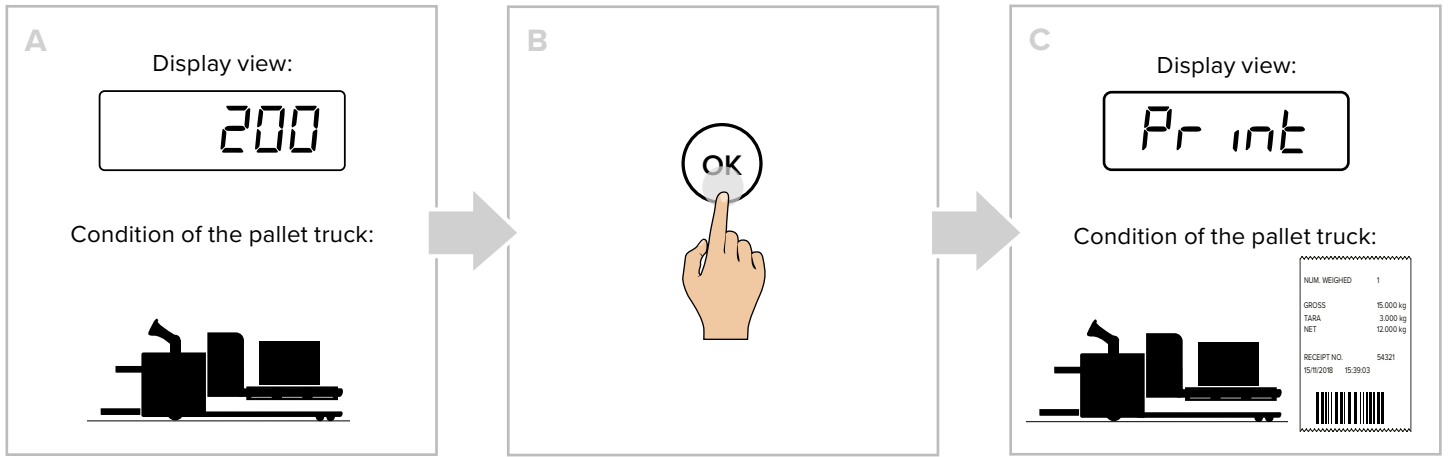

Print

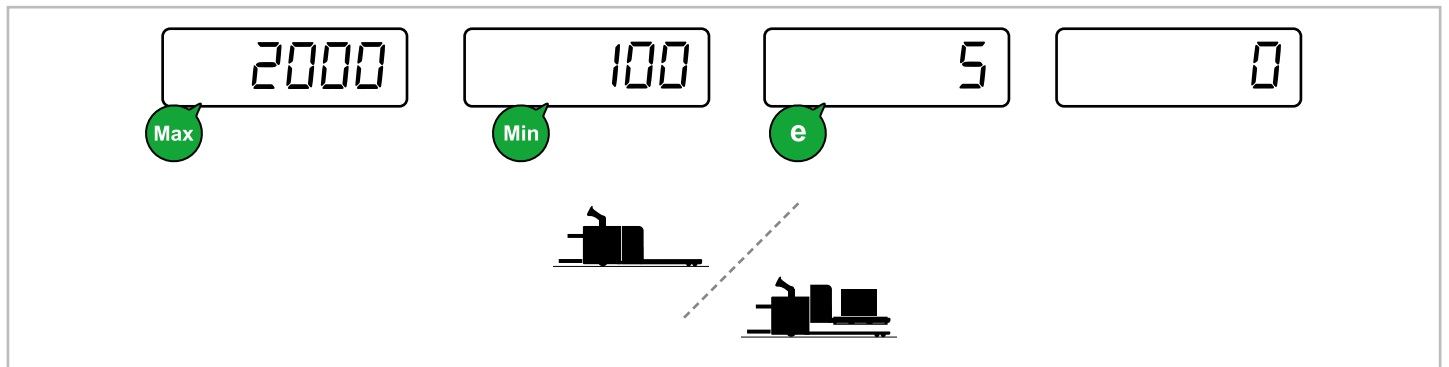
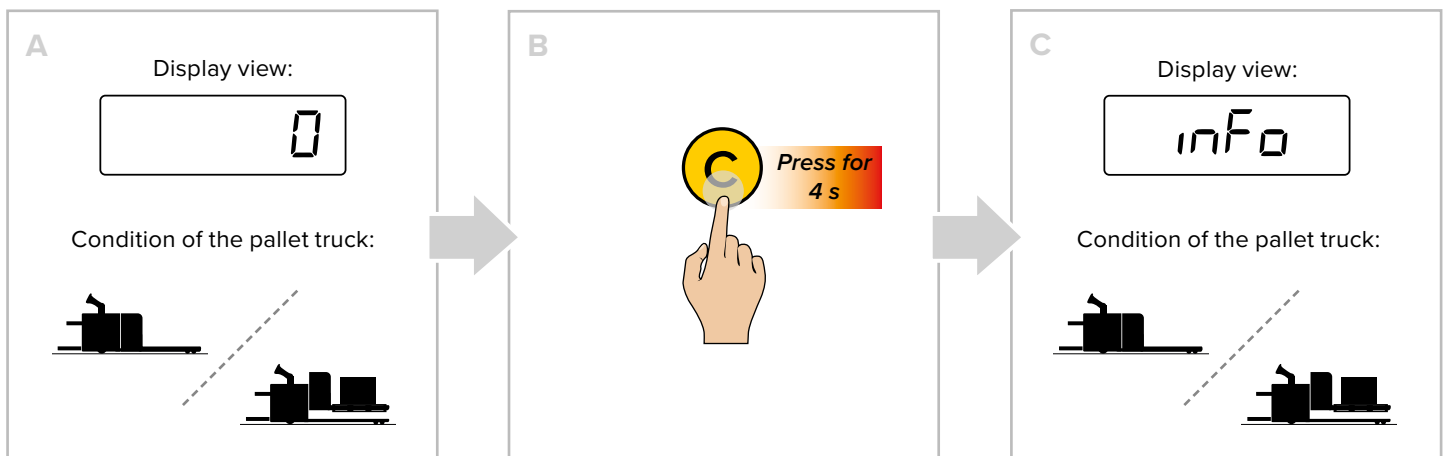

Metric information





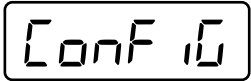

How to enter the functions menu

A Display view:  Condition of the pallet truck: 

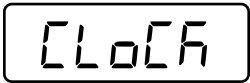
B  **Press for 5 s**





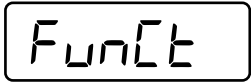

C Display view:  "CONF IG" will flash on the indicator for a few seconds

D Display view:  The indicator has entered the configuration menu, scroll through the parameters with the keys  and  and select the "NoDE" step

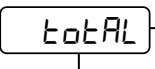

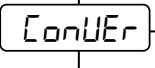
E Display view:  

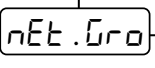
F Display view:  "FunCT" will flash on the indicator for a few seconds.

G

-   **Horizontal weight totalisation**
Sum of the weight of multiple objects to determine the total weight
-   **Exchange net weight / gross weight**
-   **Unit of measure conversion**

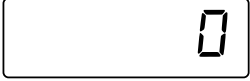
The scale goes back to weighing mode after selecting the function.

 

Horizontal weight totalisation

HOW TO SUM THE WEIGHS

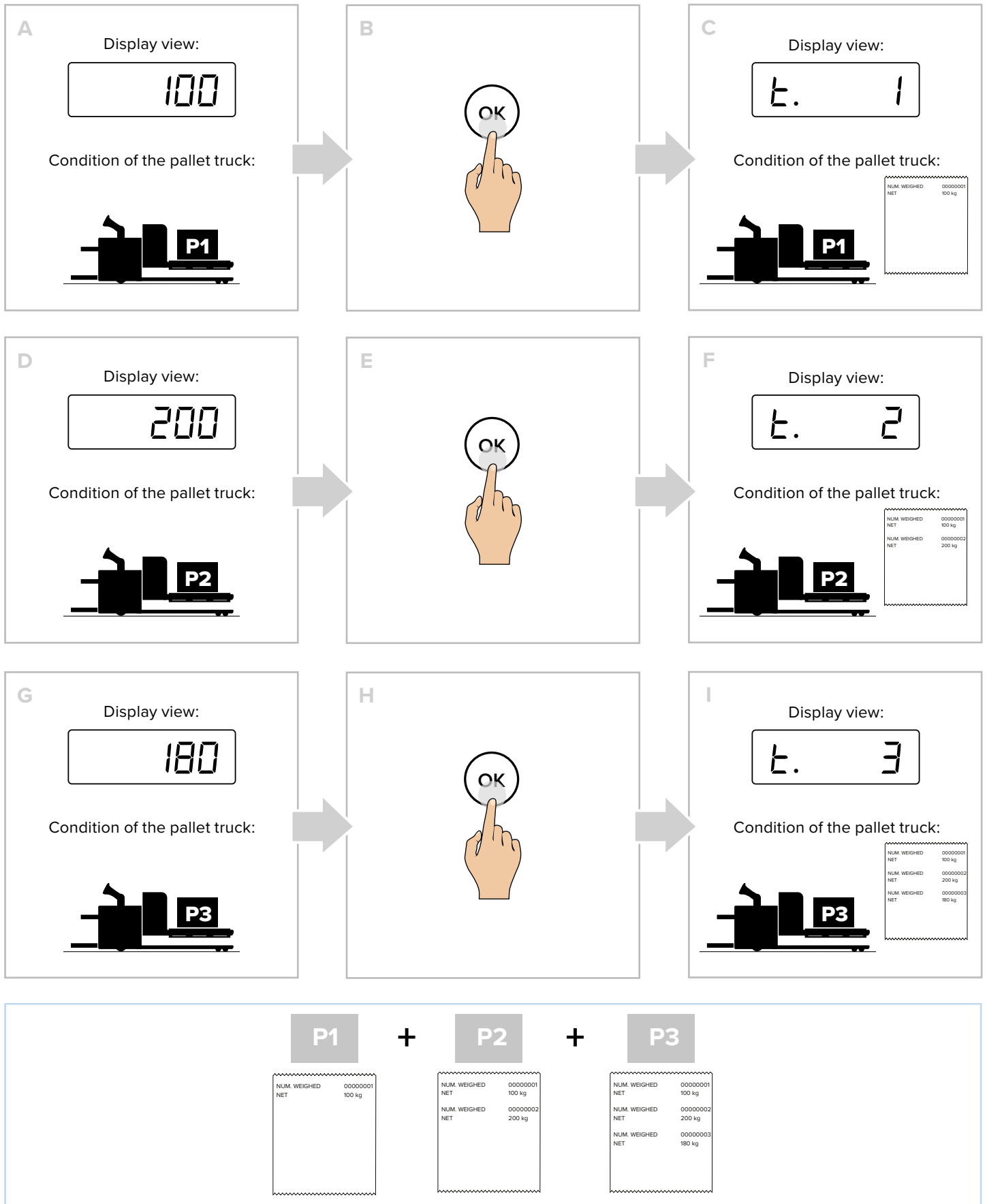

HOW TO MOMENTARILY READ THE TOTAL

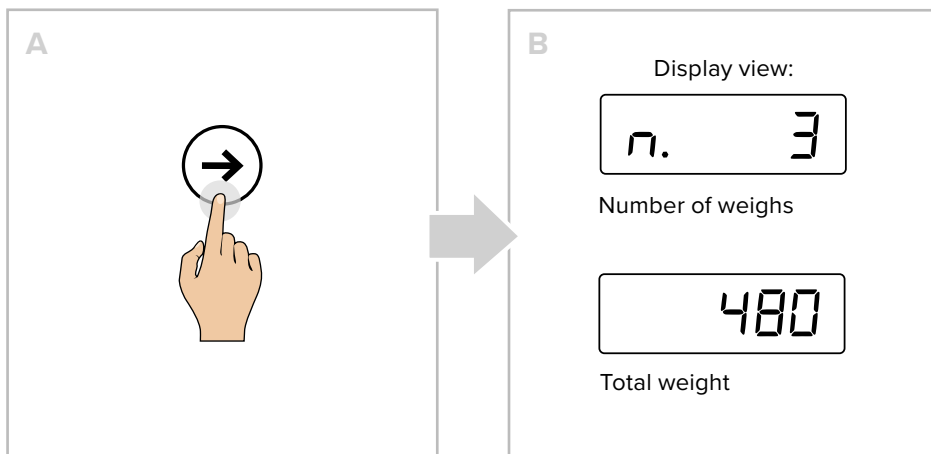

HOW TO END WEIGHT TOTALISATION AND ZERO THE TOTAL

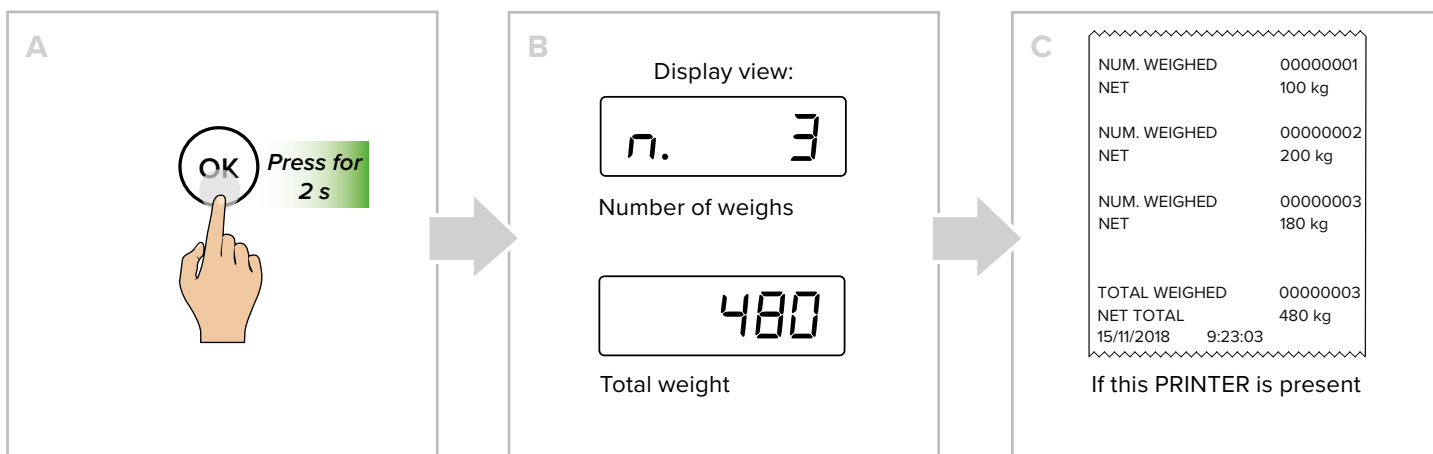

HOW TO PRINT AND ZERO THE GRAND TOTAL

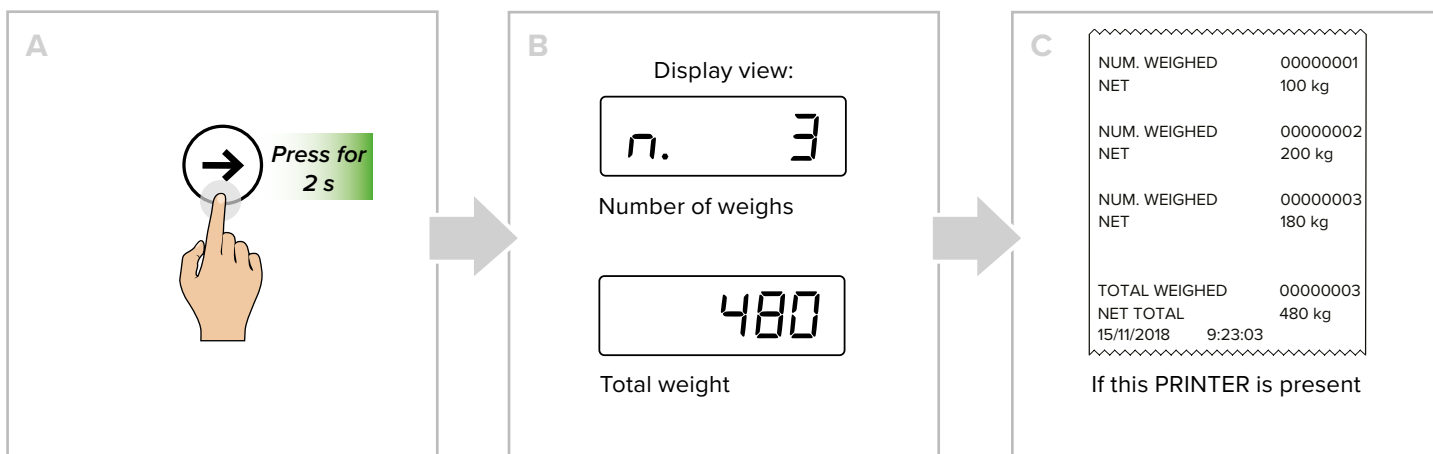

Exchange between net weight and gross weight

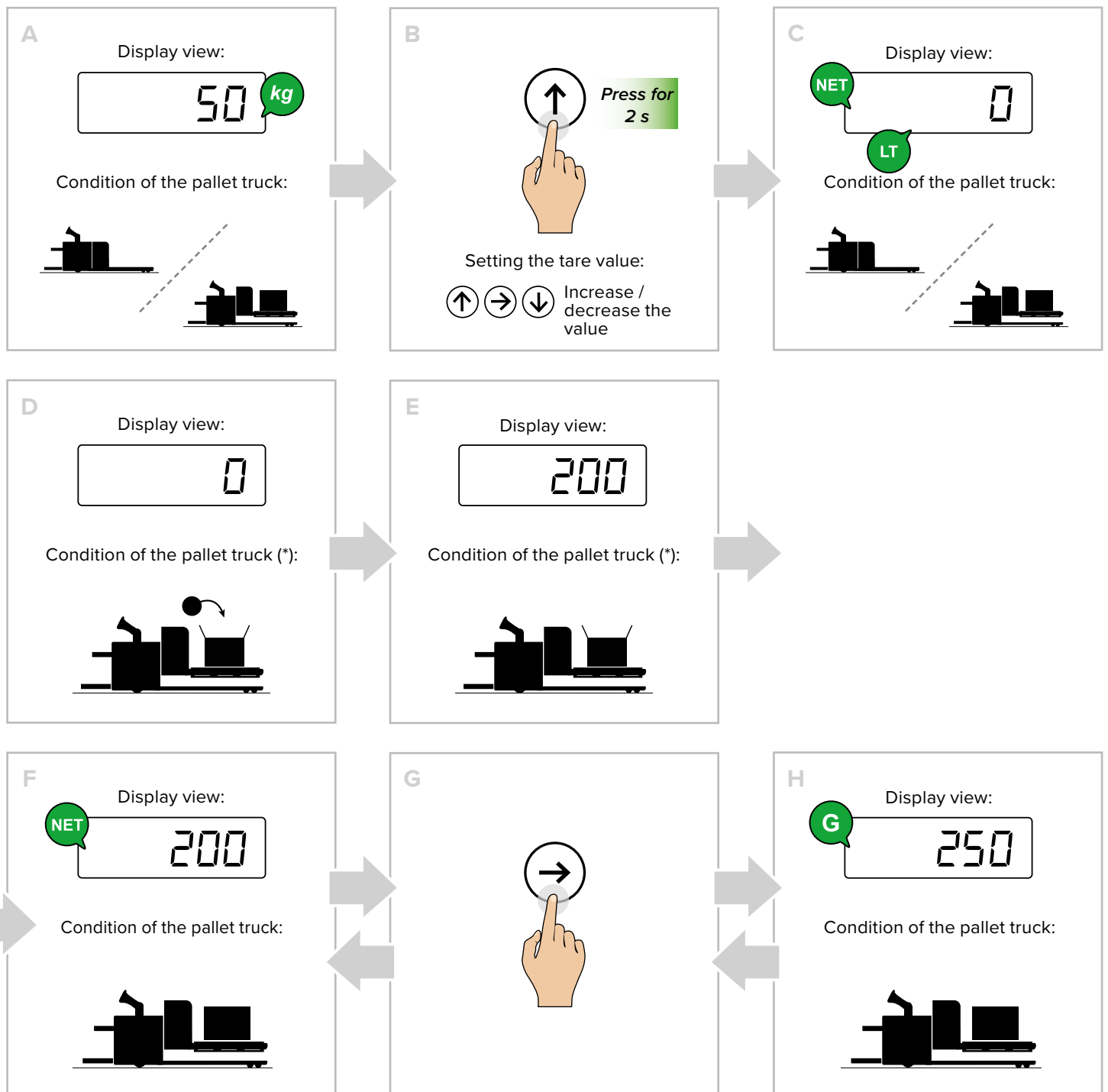

By pressing ^{MODE} at any time, you can change from net to gross weight.



The forks must always be fully lowered and raised to acquire a new weight.

Unit of measure conversion

HOW TO CONVERT THE UNIT OF MEASUREMENT TO POUNDS (STANDARD MODE)

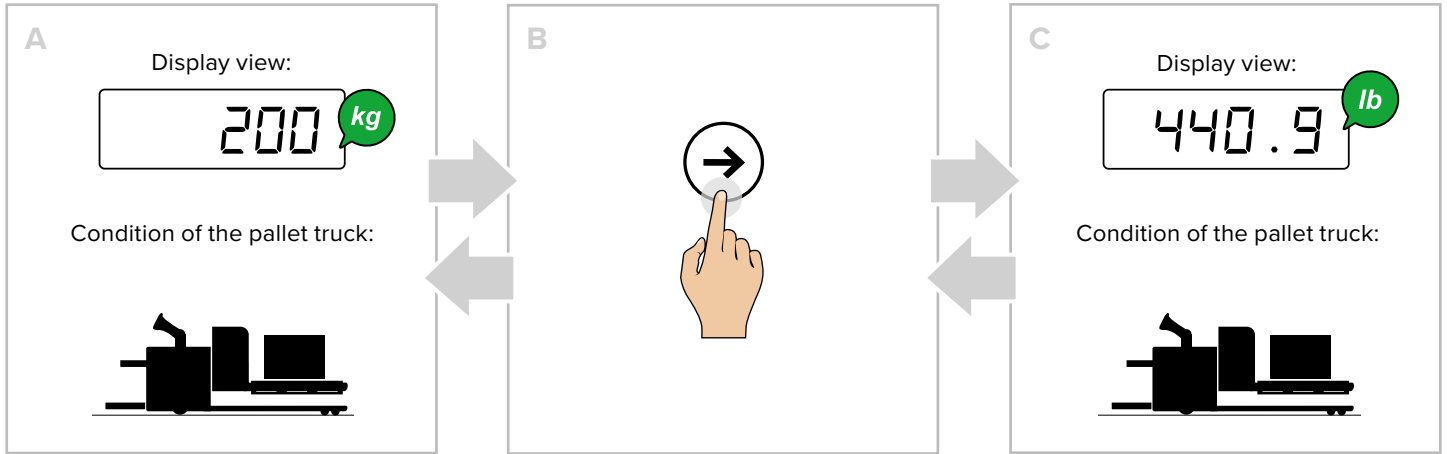

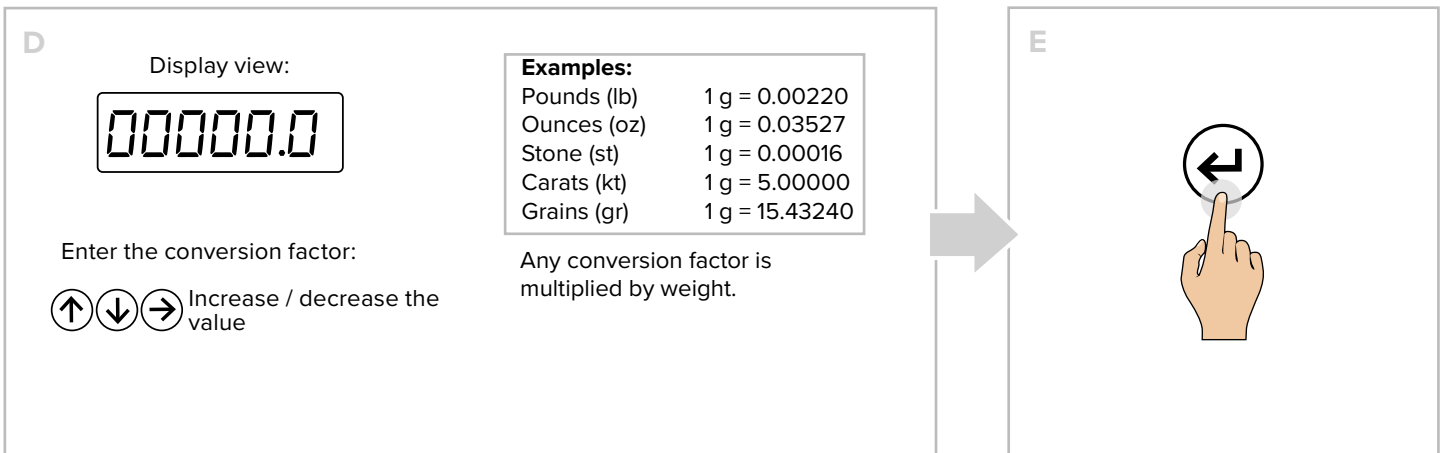
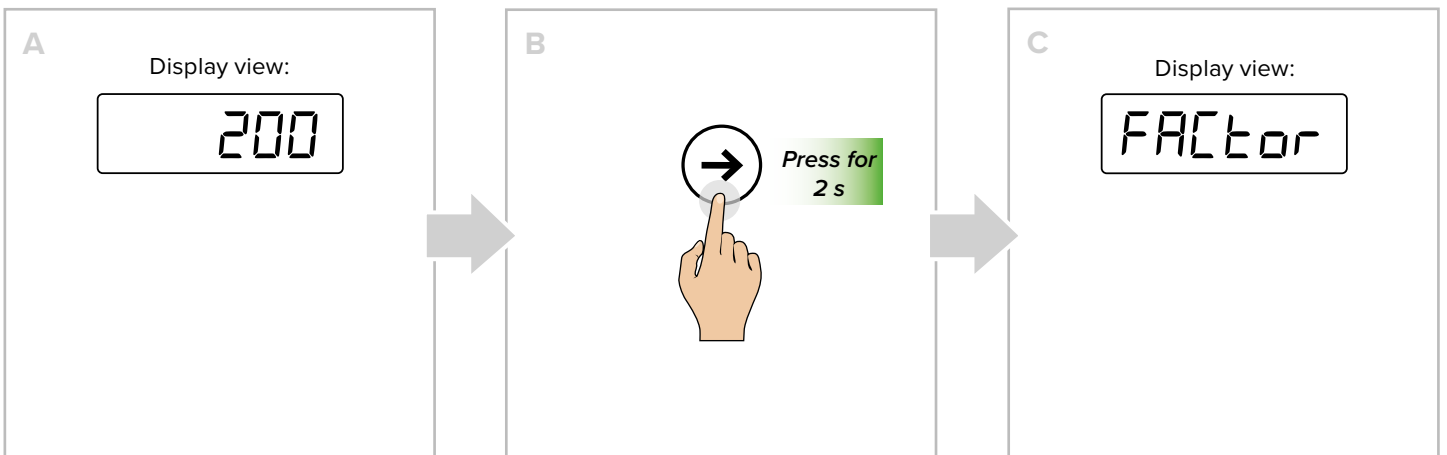

i By pressing  at any time you can switch from weight in kg to weight in pounds.

HOW TO CONVERT THE UNIT OF MEASUREMENT WITH FREE CONVERSION FACTOR

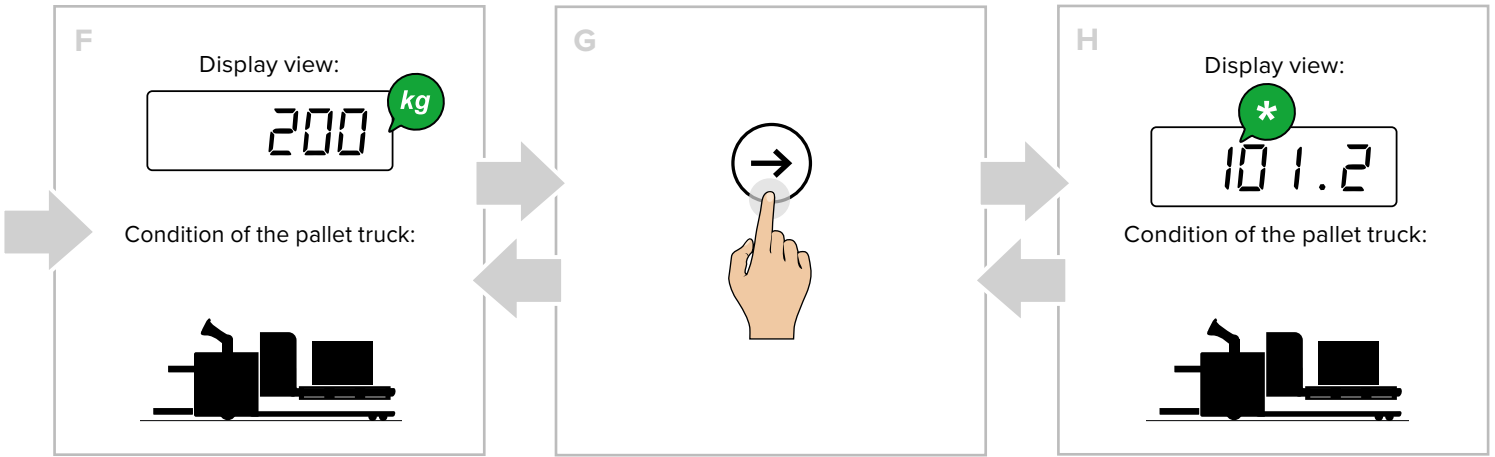

proceed →



i By pressing ^{MODE}  at any time, the unit of measurement can be converted with a free conversion factor.



MENU

CLoCh - DATE AND TIME

How to enter

1. 5 Sec.



How to browse

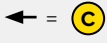
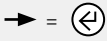
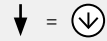
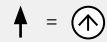

Day

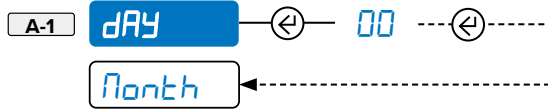

Month

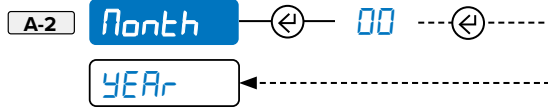

Year

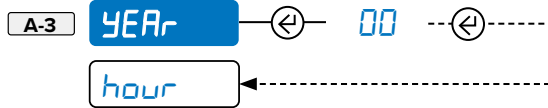

Hour

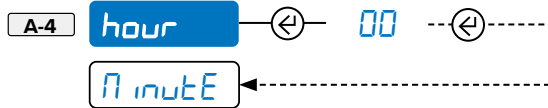

Minute

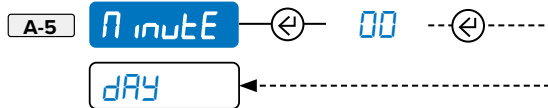



MENU

How to enter

1. 5 Sec.



How to browse

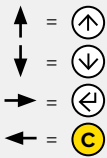

A CLoCK

B dYn.HGt

C PrEC.10

D SCrEEen

E AutoFF

E t.r.rES

F d.rG

G ModE

H rAh.HGt

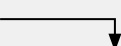

1 d.u.znF

2 d.u.unF

3 HGt.unF

4 t.r.AUG

dYn.HGt - SENSOR FINE TUNING

Advanced configuration parameters. For use by the installer.

B-1 d.u.znF

B-2 d.u.unF

B-3 HGt.unF

B-4 t.r.AUG

Refer to the technical manual for more information.

PrEC.10 - HIGH RESOLUTION READING DIVISION

This functions allows you to display the weight with ten times greater resolution. For use by technical staff.

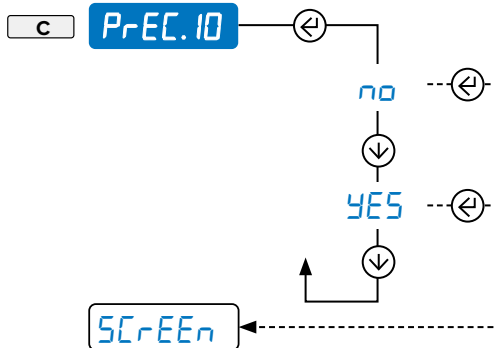



MENU

How to enter

1. 5 Sec.



How to browse

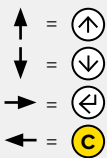

A **LoCk**

B **dYnBdGt**

C **PrEC.10**

D **SCrEEen**

E **AutoFF**

E **t iFrES**

F **d iAG**

G **ModE**

H **PrAHdGt**

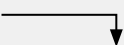

1 **bAR.L it**

2 **br iGht**

3 **LoCk**

SCrEEen - ADJUSTING THE DISPLAY

Backlighting

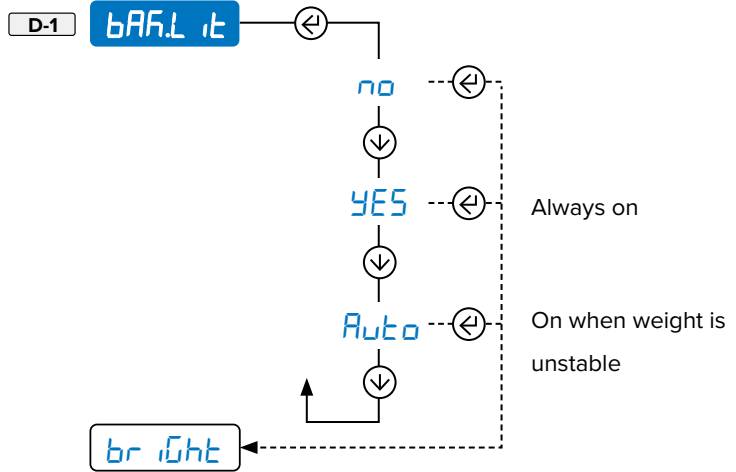

Brightness

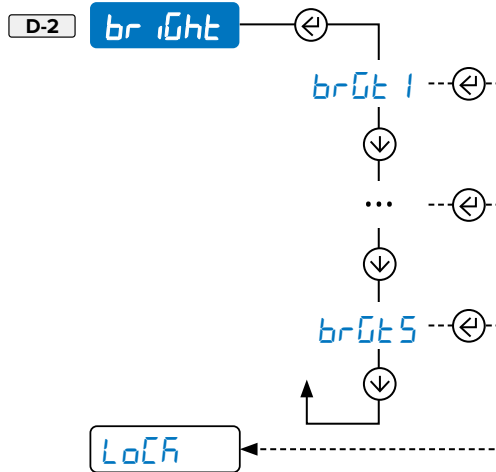

Display lock (for use by the manufacturer)

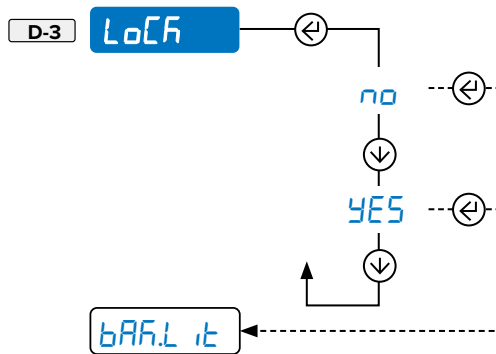



MENU

How to enter

1. 5 Sec.



How to browse

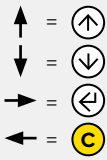

A **CLoCK**

B **dYnBt**

C **PrEC.10**

D **SCrEEr**

E **AutoFF**

E **t r r ES**

F **d i AG**

G **ModE**

H **PrAHBt**

AutoFF - AUTOMATIC SWITCH-OFF

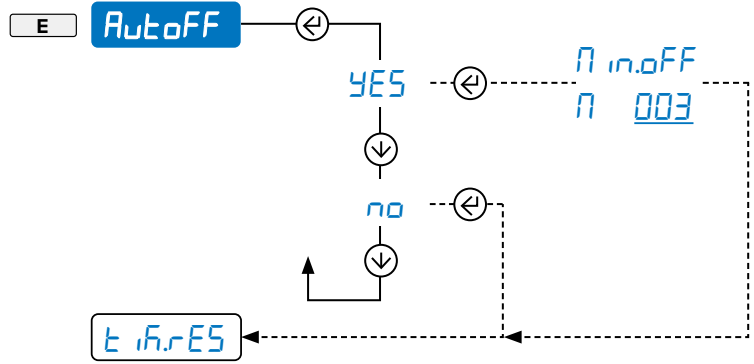

t r r ES - TICKET NUMBER RESET

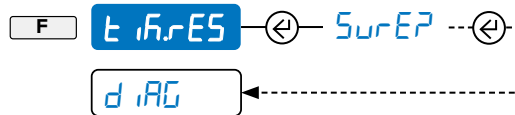

d i AG - DIAGNOSTICS

G **d i AG** Reserved for technical staff.



MENU

How to enter

1. 5 Sec.



How to browse

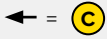
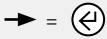
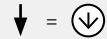
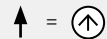

A CLoCh

B dYn.HGt

C PrEc.10

D SCrEEr

E AutoFF

E t.r.rES

F d.rG

G Node

H r.r.HGt

Node - INDICATOR FUNCTIONS

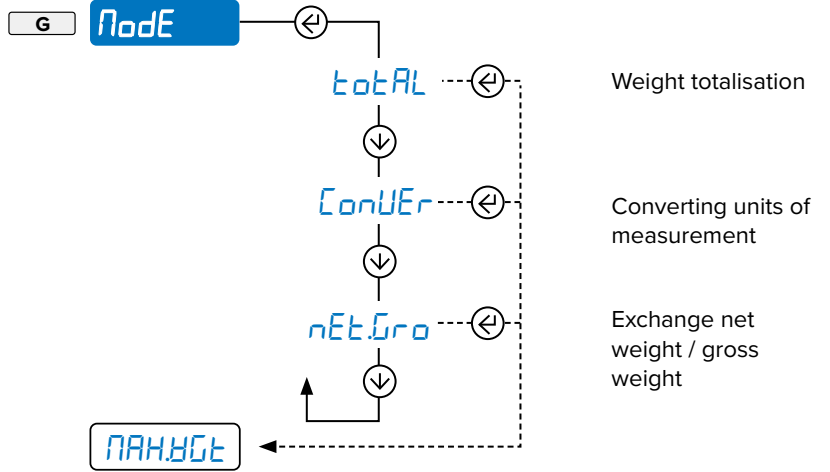

r.r.HGt - SETPOINT ON GROSS WEIGHT

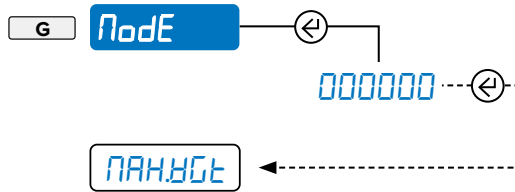

i When the gross weight exceeds the set threshold, the message "oVEr" appears on the indicator accompanied by an acoustic signal.

The results of the weighing system depend on the condition of the various parts of the pallet truck. The weighing system does not require any special maintenance, but a poor condition of the various parts of the pallet truck can negatively affect the accuracy.

For this reason, it is advisable to:

- Lubricate the chains and the mast in such a way as to reduce friction between the two components as much as possible.
- Regularly clean the pallet truck so that it operates under almost constant conditions.
- Observe the IP protection rating of the instrument when cleaning the system.

Note: It is recommended to recalibrate the weight indicator every 3 months.

Replacing the printer paper roll

To replace the roll of the **OBTPRELP** integrated thermal printer (if applicable), proceed as follows:

1. Open the door by pressing the centre key.
2. Insert the roll with the thermal surface facing outwards.
3. Close the door by pressing on both sides.
4. Remove excess paper.

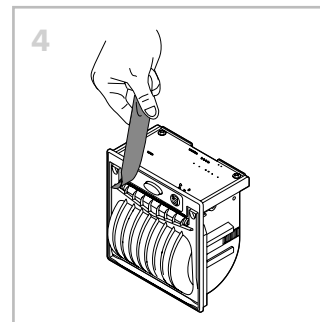
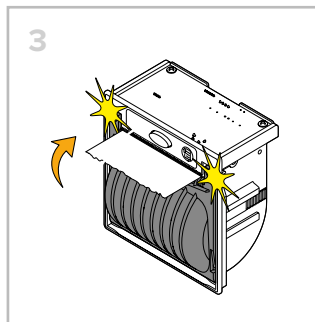
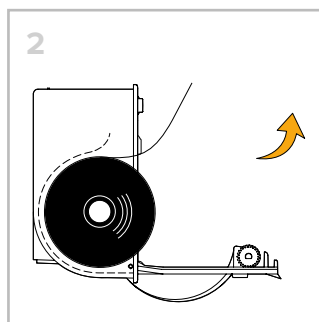
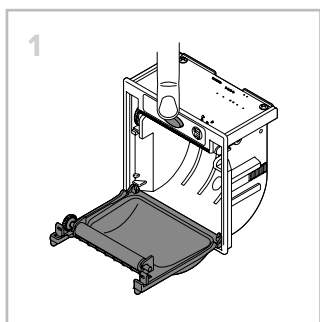





A RICE LAKE WEIGHING SYSTEMS COMPANY

HEAD OFFICE

Via Della Fisica, 20
41042 Spezzano di Fiorano, Modena - Italy
Tel. +39 0536 843418 - Fax +39 0536 843521

SERVICE ASSISTANCE

Via Dell'Elettronica, 15
41042 Spezzano di Fiorano, Modena - Italy
Tel. +39 0536 921784 - Fax +39 0536 926654

www.diniargeo.com

Stamp of the authorised service centre

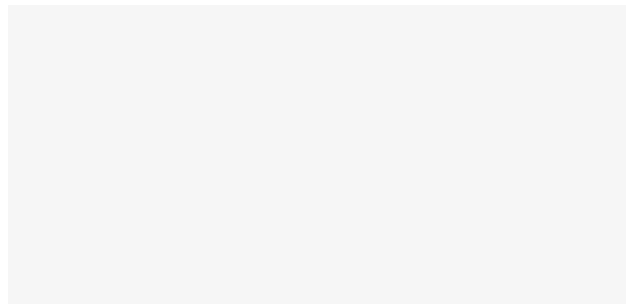

The information in this document is approximate and can be subject to variations without prior notice by Dini Argeo, in compliance with the norms in force. The official technical data are available in the updated version on the following website www.diniargeo.com or by contacting Dini Argeo Customer Service.